



SUBMITTAL DATA - INDOOR UNIT
VE4C036C432P
VRF STD 4-WAY CASSETTE TYPE EVAPORATOR
208-230/1/60

Job Name: _____
 Location: _____
 Schedule No.: _____
 System Designation: _____

Engineer: _____
 Architect: _____
 Date: _____
 For: ___ Reference ___ Approval ___ Review ___ Construction

FEATURES

- Auto Addressing installation
- Auto Restart
- Replaceable Front Panel
- Integrated Condensate Pump
- Built-in Electronic Expansion Valve
- LED Display
- Washable Filter
- Water Overflow Protection
- Anti-Freezing Protection

PRODUCT WARRANTY

All covered components - one year limited warranty

SPECIFICATIONS

PERFORMANCE

Cooling Capacity* (Btu/h)		36,000
Heating Capacity* (Btu/h)		40,000
Airflow (CFM)	High	1000
	Medium	825
	Low	650

Sound Pressure Level (dBA) H / M / L 41/38/36

ELECTRICAL DATA

Power Supply (V / Ph / Hz)		208-230/1/60
MOP (A)		15
Circuit Breaker (A)		6
MCA (A)		1
Rated Current (A)	Cooling	0.9
	Heating	0.9

DIMENSIONS

Unit Dimensions (in)	Height	12 5/8
	Width	33
	Depth	33
Panel Unit Dimensions (in)	Height	2 1/2
	Width	37 3/8
	Depth	37 3/8

Liquid Pipe Connection (in)	3/8
Gas Pipe Connection (in)	5/8
Shipping Weight (lb)	88.2
Net Weight (lb)	71.7
Panel Shipping Weight (lb)	24.3
Panel Net Weight (lb)	15

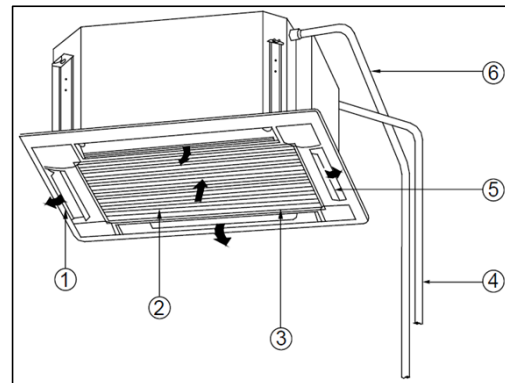

1. Air Outlet
2. Air Filter
3. Grill
4. Refrigerant Piping
5. Louvers
6. Drain Pipe

NOTES:

*Cooling and Heating Capacity data is rated at the following conditions:

Cooling: 80 °F DB / 67 °F WB Indoor, 95 °F DB Outdoor
 Heating: 70 °F DB Indoor, 47 °F DB



NOTE – Due to Lennox' ongoing commitment to quality, Specifications, Ratings and Dimensions subject to change without notice and without incurring liability. Improper installation, adjustment, alteration, service or maintenance can cause property damage or personal injury. Installation and service must be performed by a qualified installer and servicing agency. ©2019 Lennox Industries Inc.



SUBMITTAL DATA - INDOOR UNIT
VE4C036C432P
VRF STD 4-WAY CASSETTE TYPE EVAPORATOR
208-230/1/60

DIMENSIONAL DRAWINGS

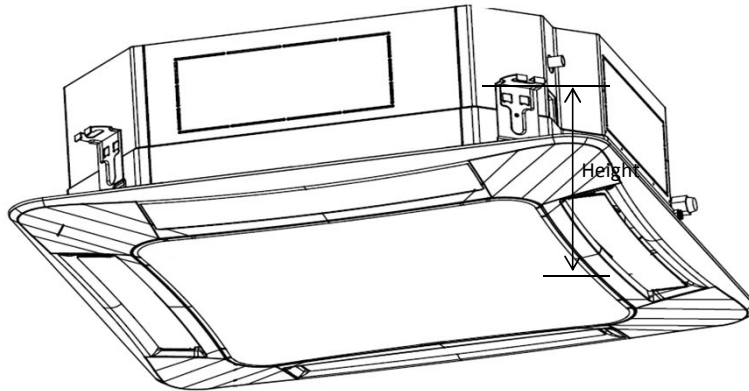
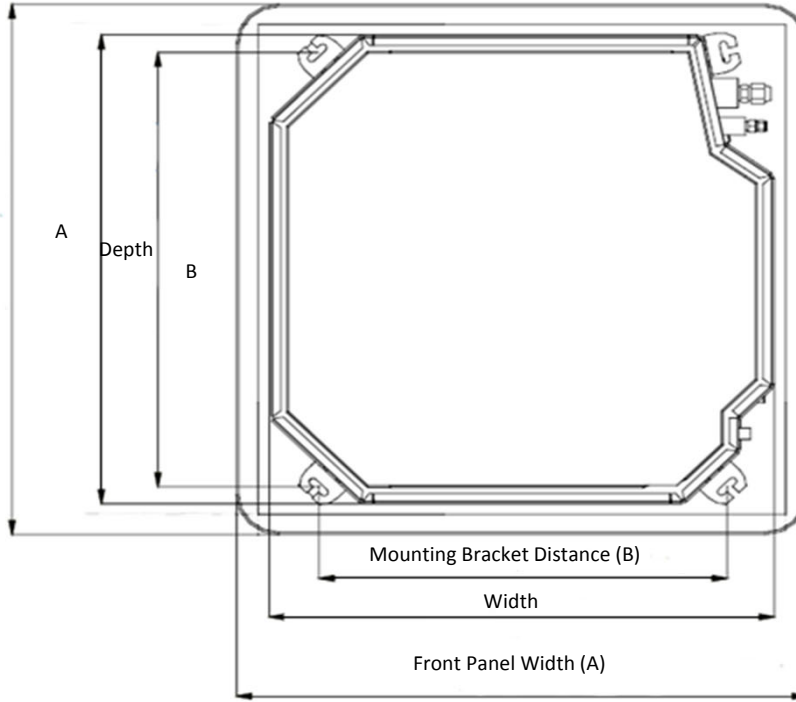

	mm	in
Width	840	33.07
Depth	840	33.07
Height	240	9.45
A	950	37.40
B	680	26.77

NOTE – Due to Lennox' ongoing commitment to quality, Specifications, Ratings and Dimensions subject to change without notice and without incurring liability. Improper installation, adjustment, alteration, service or maintenance can cause property damage or personal injury. Installation and service must be performed by a qualified installer and servicing agency. ©2019 Lennox Industries Inc.