



SUBMITTAL DATA - INDOOR UNIT
VEHD042C432P
VRF HIGH STATIC FAN COIL EVAPORATOR
208-230/1/60

Job Name: _____
Location: _____
Schedule No.: _____
System Designation: _____

Engineer: _____
Architect: _____
Date: _____
For: ___ Reference ___ Approval ___ Review ___ Construction

FEATURES

- Auto Addressing installation
- Auto Restart
- Adjustable ESP Setting
- Integrated Condensate Pump
- Built-in Electronic Expansion Valve
- LED Display Optional
- Flare Connections
- Anti-Freezing Protection
- Steel Cabinet

PRODUCT WARRANTY

All covered components - one year limited warranty

SPECIFICATIONS

PERFORMANCE

Cooling Capacity* (Btu/h)		41,968
Heating Capacity* (Btu/h)		47,086
Airflow (CFM)	High	1180
	Medium	910
	Low	705
External Static Pressure	Pa	0 - 100
	in. WC	0 - 0.4
Sound Pressure Level (dBA)	H / M / L	48/45/42

ELECTRICAL DATA

Power Supply (V / Ph / Hz)		208-230/1/60
MOCP (A)		15
MCA (A)		2
Rated Current (A)	Cooling	1.6
	Heating	1.6

DIMENSIONS

Unit Dimensions (in)	Height	11 1/2
	Width	48 1/2
	Depth	30 1/2
Liquid Pipe Connection (in)		3/8
Gas Pipe Connection (in)		5/8
Drain Pipe Connection (in)		3/4
Shipping Weight (lb)		119.1
Net Weight (lb)		103.6

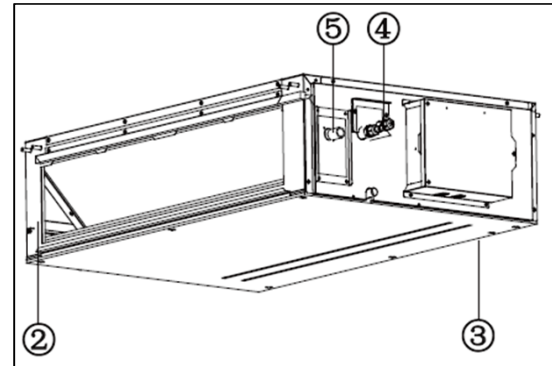
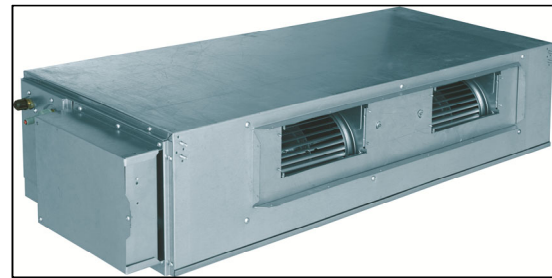

1. Air Filter
2. Air Inlet
3. Air Outlet
4. Fittings
5. Drain Pipe

NOTES:

*Cooling and Heating Capacity data is rated at the following conditions:

Cooling: 80 °F DB / 67 °F WB Indoor, 95 °F DB Outdoor

Heating: 70 °F DB Indoor, 47 °F DB



NOTE – Due to Lennox' ongoing commitment to quality, Specifications, Ratings and Dimensions subject to change without notice and without incurring liability. Improper installation, adjustment, alteration, service or maintenance can cause property damage or personal injury. Installation and service must be performed by a qualified installer and servicing agency. ©2019 Lennox Industries Inc.



SUBMITTAL DATA - INDOOR UNIT
VEHD042C432P
VRF HIGH STATIC FAN COIL EVAPORATOR
208-230/1/60

DIMENSIONAL DRAWINGS

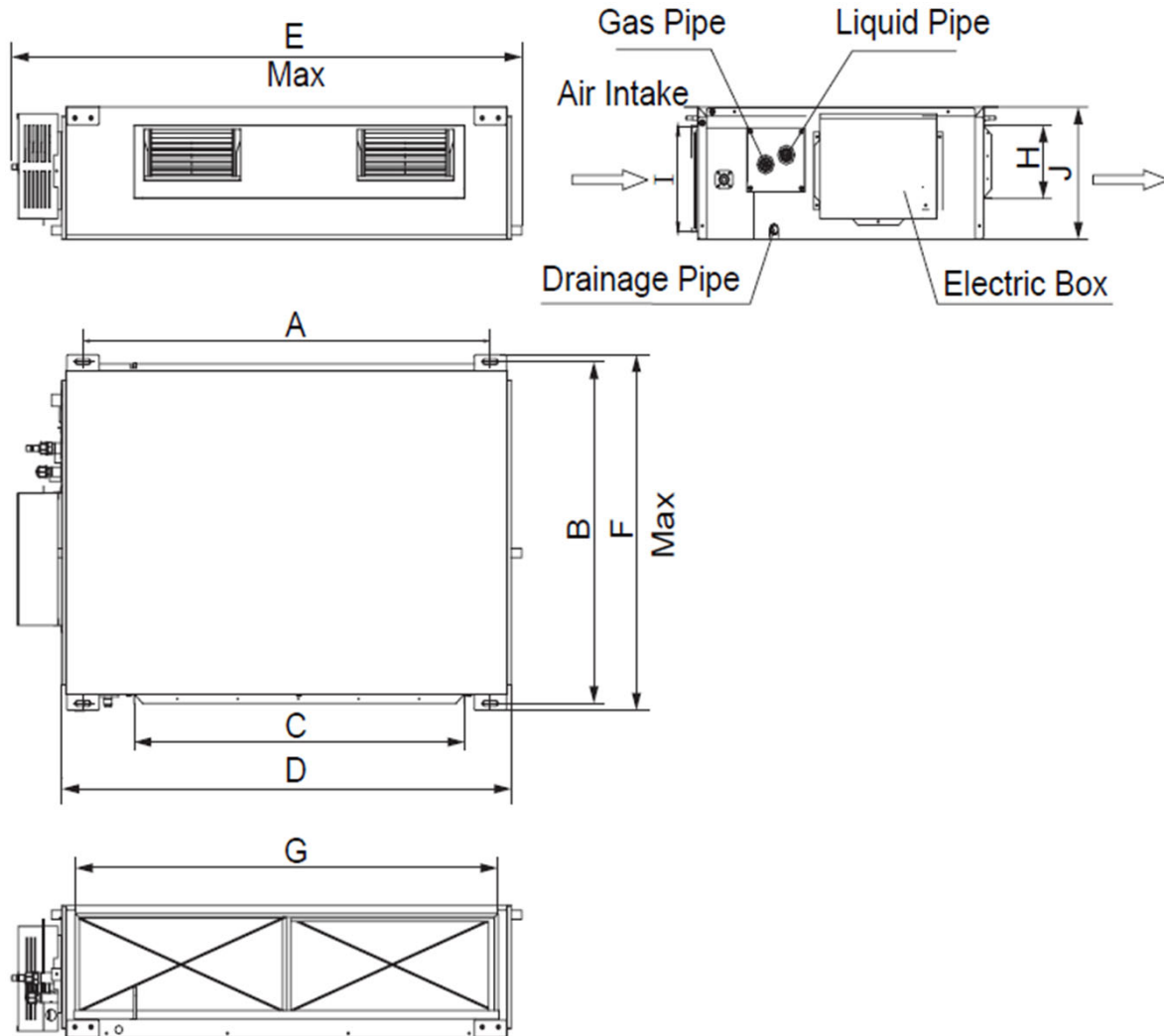

	mm	in
A	1011	39.80
B	748	29.45
C	820	32.28
D	1115	43.90
E	1229	48.39
F	775	30.51
G	979	38.54
H	160	6.30
I	231	9.09
J	290	11.42

NOTE – Due to Lennox' ongoing commitment to quality, Specifications, Ratings and Dimensions subject to change without notice and without incurring liability. Improper installation, adjustment, alteration, service or maintenance can cause property damage or personal injury. Installation and service must be performed by a qualified installer and servicing agency. ©2019 Lennox Industries Inc.