



**SUBMITTAL DATA - INDOOR UNIT**  
**VELD007C432P**  
**VRF LOW STATIC FAN COIL EVAPORATOR**  
**220-240/1/50 - 208-230/1/60**

**Job Name:** \_\_\_\_\_  
**Location:** \_\_\_\_\_  
**Schedule No.:** \_\_\_\_\_  
**System Designation:** \_\_\_\_\_

**Engineer:** \_\_\_\_\_  
**Architect:** \_\_\_\_\_  
**Date:** \_\_\_\_\_  
**For:** \_\_\_ Reference \_\_\_ Approval \_\_\_ Review \_\_\_ Construction

**FEATURES**

- Auto Addressing installation
- Auto Restart
- Detachable Blower Motor
- Integrated Condensate Pump
- Built-in Electronic Expansion Valve
- LED Display Optional
- Washable Filter
- Water Overflow Protection
- Anti-Freezing Protection

**PRODUCT WARRANTY**

All covered components - one year limited warranty

**SPECIFICATIONS**

**PERFORMANCE**

Cooling Capacity* (Btu/h)		7,500
Heating Capacity* (Btu/h)		8,500
Airflow (CFM)	High	265
	Medium	235
	Low	150
External Static Pressure	Pa	0 - 30
	in. WC	0 - 0.12
Sound Pressure Level (dBA)	H / M / L	31/29/25

**ELECTRICAL DATA**

Power Supply (V / Ph / Hz)	220-240/1/50 - 208-230/1/60	
MOCP (A)	15	
Circuit Breaker (A)	6	
MCA (A)	1	
Rated Current (A)	Cooling	0.3
	Heating	0.3

**DIMENSIONS**

Unit Dimensions (in)	Height	7 7/8
	Width	27 1/2
	Depth	24 1/4
Liquid Pipe Connection (in)		1/4
Gas Pipe Connection (in)		3/8
Drain Pipe Connection (in)		1
Shipping Weight (lb)		63.8
Net Weight (lb)		50.6

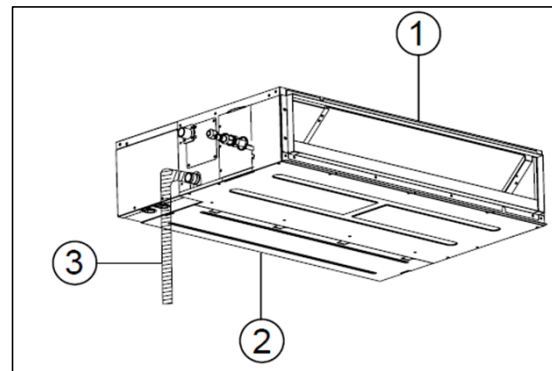

1. Air Outlet
2. Air-Return Opening
3. Drain Pipe

**NOTES:**

\*Cooling and Heating Capacity data is rated at the following conditions:

Cooling: 80 °F DB / 67 °F WB Indoor, 95 °F DB Outdoor

Heating: 70 °F DB Indoor, 47 °F DB



NOTE – Due to Lennox' ongoing commitment to quality, Specifications, Ratings and Dimensions subject to change without notice and without incurring liability. Improper installation, adjustment, alteration, service or maintenance can cause property damage or personal injury. Installation and service must be performed by a qualified installer and servicing agency. ©2019 Lennox Industries Inc.



**SUBMITTAL DATA - INDOOR UNIT**  
**VELD007C432P**  
**VRF LOW STATIC FAN COIL EVAPORATOR**  
**220-240/1/50 - 208-230/1/60**

**DIMENSIONAL DRAWINGS**

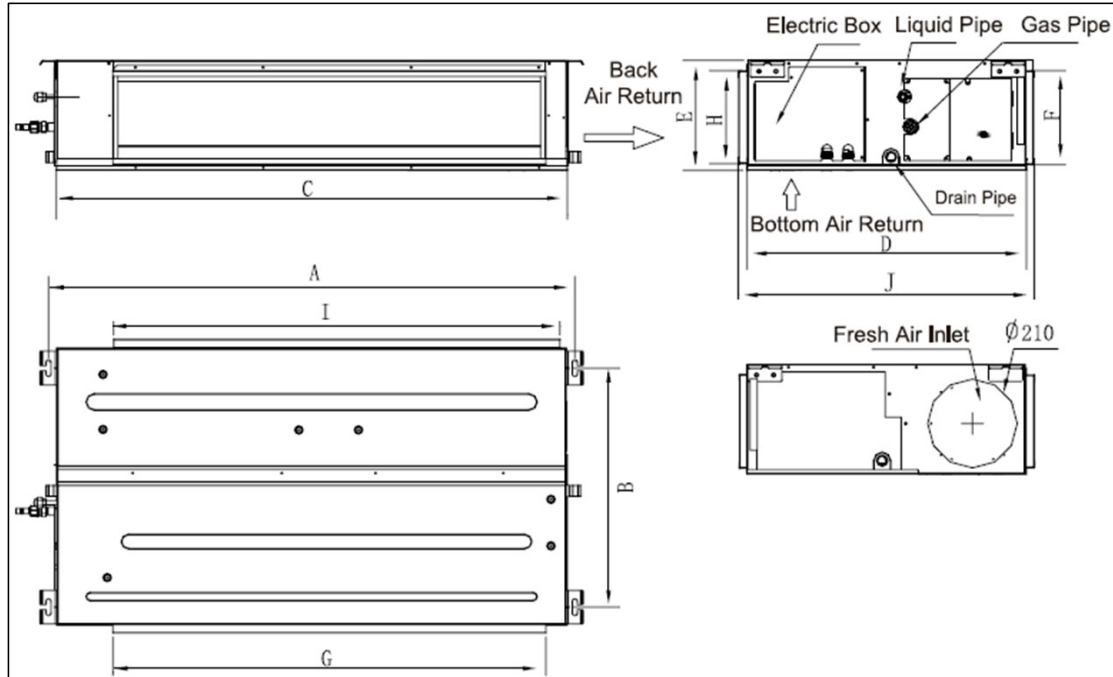

	mm	in
<b>A</b>	742	29.21
<b>B</b>	491	19.33
<b>C</b>	700	27.56
<b>D</b>	615	24.21
<b>E</b>	200	7.87
<b>F</b>	121	4.76
<b>G</b>	528	20.79
<b>H</b>	161	6.34
<b>I</b>	580	22.83

NOTE – Due to Lennox' ongoing commitment to quality, Specifications, Ratings and Dimensions subject to change without notice and without incurring liability. Improper installation, adjustment, alteration, service or maintenance can cause property damage or personal injury. Installation and service must be performed by a qualified installer and servicing agency. ©2019 Lennox Industries Inc.