



SUBMITTAL DATA - INDOOR UNIT
VELD009C432P
VRF LOW STATIC FAN COIL EVAPORATOR
220-240/1/50 - 208-230/1/60

Job Name: _____
Location: _____
Schedule No.: _____
System Designation: _____

Engineer: _____
Architect: _____
Date: _____
For: ___ Reference ___ Approval ___ Review ___ Construction

FEATURES

- Auto Addressing installation
- Auto Restart
- Detachable Blower Motor
- Integrated Condensate Pump
- Built-in Electronic Expansion Valve
- LED Display Optional
- Washable Filter
- Water Overflow Protection
- Anti-Freezing Protection

PRODUCT WARRANTY

All covered components - one year limited warranty

SPECIFICATIONS

PERFORMANCE

Cooling Capacity* (Btu/h)		9,500
Heating Capacity* (Btu/h)		10,500
Airflow (CFM)	High	265
	Medium	235
	Low	150
External Static Pressure	Pa	0 - 30
	in. WC	0 - 0.12
Sound Pressure Level (dBA)	H / M / L	31/29/25

ELECTRICAL DATA

Power Supply (V / Ph / Hz)	220-240/1/50 - 208-230/1/60	
MOCP (A)		15
Circuit Breaker (A)		6
MCA (A)		1
Rated Current (A)	Cooling	0.3
	Heating	0.3

DIMENSIONS

Unit Dimensions (in)	Height	7 7/8
	Width	27 1/2
	Depth	24 1/4
Liquid Pipe Connection (in)		1/4
Gas Pipe Connection (in)		3/8
Drain Pipe Connection (in)		1
Shipping Weight (lb)		63.8
Net Weight (lb)		50.6

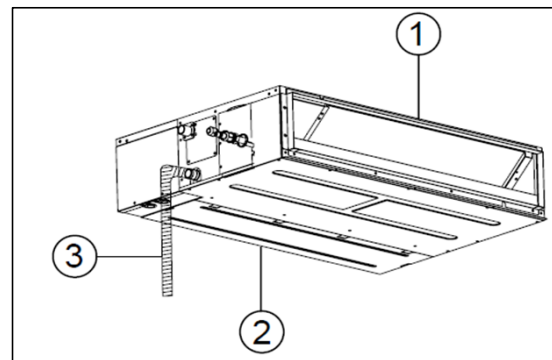

1. Air Outlet
2. Air-Return Opening
3. Drain Pipe

NOTES:

*Cooling and Heating Capacity data is rated at the following conditions:

Cooling: 80 °F DB / 67 °F WB Indoor, 95 °F DB Outdoor
 Heating: 70 °F DB Indoor, 47 °F DB



NOTE – Due to Lennox' ongoing commitment to quality, Specifications, Ratings and Dimensions subject to change without notice and without incurring liability. Improper installation, adjustment, alteration, service or maintenance can cause property damage or personal injury. Installation and service must be performed by a qualified installer and servicing agency. ©2019 Lennox Industries Inc.



SUBMITTAL DATA - INDOOR UNIT
VELD009C432P
VRF LOW STATIC FAN COIL EVAPORATOR
220-240/1/50 - 208-230/1/60

DIMENSIONAL DRAWINGS

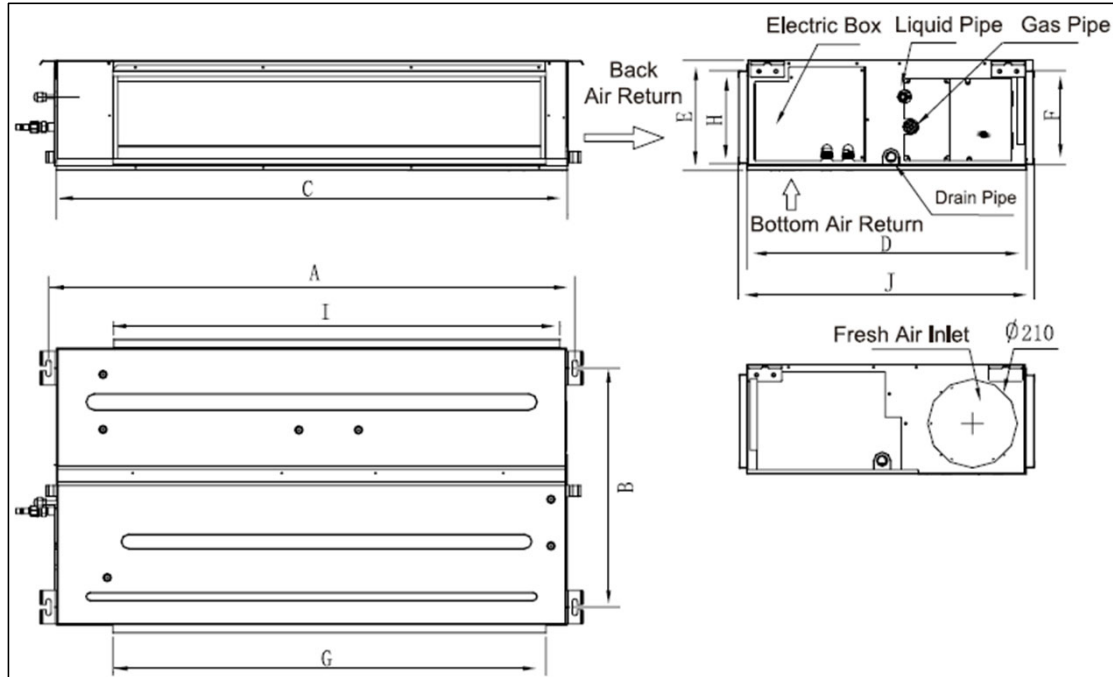

	mm	in
A	742	29.21
B	491	19.33
C	700	27.56
D	615	24.21
E	200	7.87
F	121	4.76
G	528	20.79
H	161	6.34
I	580	22.83

NOTE – Due to Lennox' ongoing commitment to quality, Specifications, Ratings and Dimensions subject to change without notice and without incurring liability. Improper installation, adjustment, alteration, service or maintenance can cause property damage or personal injury. Installation and service must be performed by a qualified installer and servicing agency. ©2019 Lennox Industries Inc.