



**SUBMITTAL DATA - INDOOR UNIT**  
**VEXD036C432P**  
**VRF HIGH STATIC FAN COIL EVAPORATOR**  
**208-230/1/60**

**Job Name:** \_\_\_\_\_  
**Location:** \_\_\_\_\_  
**Schedule No.:** \_\_\_\_\_  
**System Designation:** \_\_\_\_\_

**Engineer:** \_\_\_\_\_  
**Architect:** \_\_\_\_\_  
**Date:** \_\_\_\_\_  
**For:** \_\_\_ Reference \_\_\_ Approval \_\_\_ Review \_\_\_ Construction

**FEATURES**

- Auto Addressing installation
- Auto Restart
- Adjustable ESP Setting
- Integrated Condensate Pump
- Built-in Electronic Expansion Valve
- LED Display Optional
- Brazing Connections
- Anti-Freezing Protection
- Steel Cabinet

**PRODUCT WARRANTY**

All covered components - one year limited warranty

**SPECIFICATIONS**

**PERFORMANCE**

Cooling Capacity* (Btu/h)		36,000
Heating Capacity* (Btu/h)		40,000
Airflow (CFM)	High	1177
	Medium	942
	Low	824
External Static Pressure	Pa	90/0~200
	in. WC	0.36/0~0.8
Sound Pressure Level (dBA)	H / M / L	45/42/40

**ELECTRICAL DATA**

Power Supply (V / Ph / Hz)		208-230/1/60
MOCP (A)		15
MCA (A)		1.7
Rated Current (A)	Cooling	1.2
	Heating	1.2
Fan Quantity		3

**DIMENSIONS**

Unit Dimensions (in)	Height	11 3/4
	Width	55 1/8
	Depth	27 1/2

Liquid Pipe Connection (in)	3/8
Gas Pipe Connection (in)	5/8
Drain Pipe Connection (in)	1
Shipping Weight (lb)	137
Net Weight (lb)	121

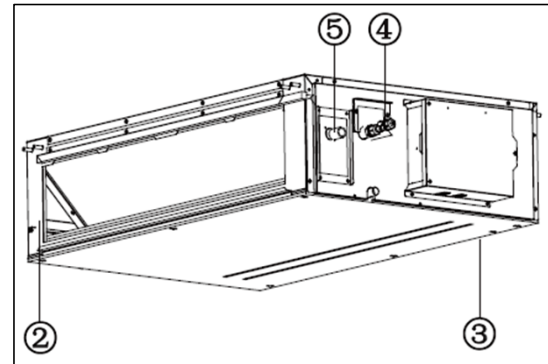

1. Air Filter
2. Air Inlet
3. Air Outlet
4. Fittings
5. Drain Pipe

**NOTES:**

\*Cooling and Heating Capacity data is rated at the following conditions:

Cooling: 80 °F DB / 67 °F WB Indoor, 95 °F DB Outdoor

Heating: 70 °F DB Indoor, 47 °F DB



NOTE – Due to Lennox' ongoing commitment to quality, Specifications, Ratings and Dimensions subject to change without notice and without incurring liability. Improper installation, adjustment, alteration, service or maintenance can cause property damage or personal injury. Installation and service must be performed by a qualified installer and servicing agency. ©2019 Lennox Industries Inc.



**SUBMITTAL DATA - INDOOR UNIT**  
**VEXD036C432P**  
**VRF HIGH STATIC FAN COIL EVAPORATOR**  
**208-230/1/60**

**DIMENSIONAL DRAWINGS**

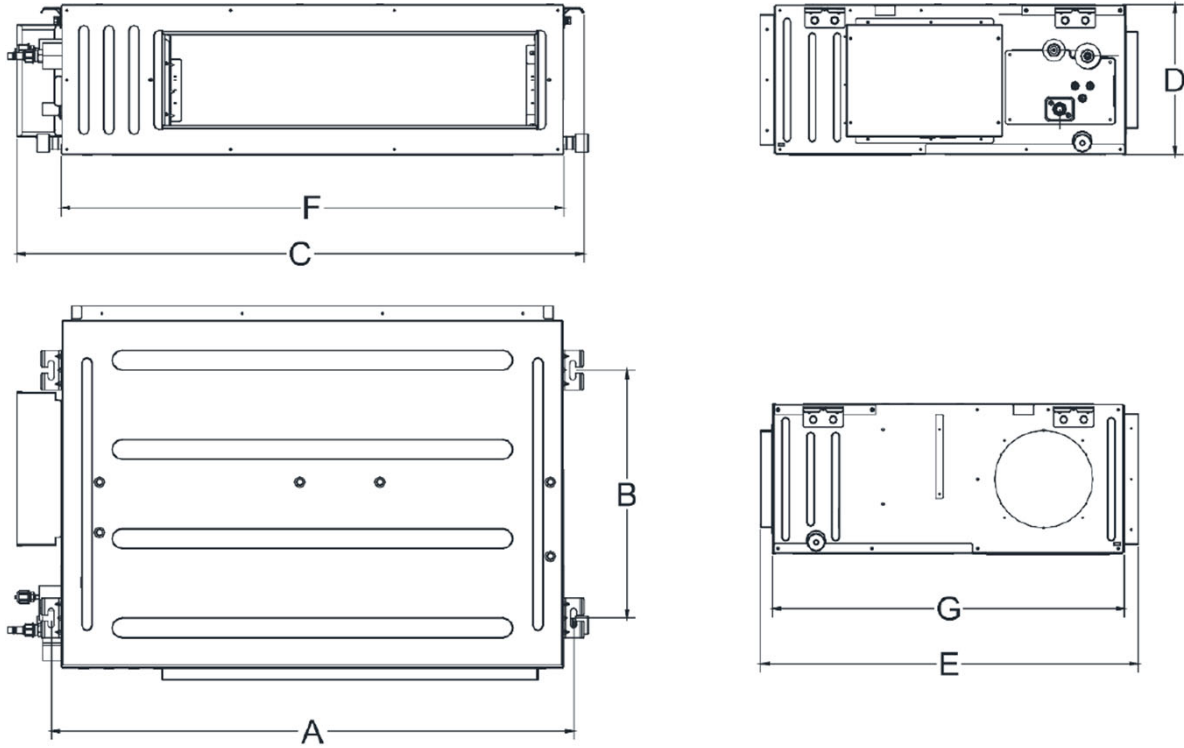

	mm	in
<b>A</b>	1440	56-11/16
<b>B</b>	500	19-11/16
<b>C</b>	1530	60-1/4
<b>D</b>	300	11-13/16
<b>E</b>	754	29-11/16
<b>F</b>	1400	55-1/8
<b>G</b>	700	27-9/16

NOTE – Due to Lennox' ongoing commitment to quality, Specifications, Ratings and Dimensions subject to change without notice and without incurring liability. Improper installation, adjustment, alteration, service or maintenance can cause property damage or personal injury. Installation and service must be performed by a qualified installer and servicing agency. ©2019 Lennox Industries Inc.