



SUBMITTAL DATA - INDOOR UNIT
VEXD048C432P
VRF HIGH STATIC FAN COIL EVAPORATOR
208-230/1/60

Job Name: _____
Location: _____
Schedule No.: _____
System Designation: _____

Engineer: _____
Architect: _____
Date: _____
For: ___ Reference ___ Approval ___ Review ___ Construction

FEATURES

- Auto Addressing installation
- Auto Restart
- Adjustable ESP Setting
- Integrated Condensate Pump
- Built-in Electronic Expansion Valve
- LED Display Optional
- Brazing Connections
- Anti-Freezing Protection
- Steel Cabinet

PRODUCT WARRANTY

All covered components - one year limited warranty

SPECIFICATIONS

PERFORMANCE

Cooling Capacity* (Btu/h)		48,000
Heating Capacity* (Btu/h)		54,000
Airflow (CFM)	High	1383
	Medium	1118
	Low	971
External Static Pressure	Pa	90/0~200
	in. WC	0.36/0~0.8
Sound Pressure Level (dBA)	H / M / L	46/43/41

ELECTRICAL DATA

Power Supply (V / Ph / Hz)		208-230/1/60
MOCP (A)		15
MCA (A)		1.7
Rated Current (A)	Cooling	1.3
	Heating	1.3
Fan Quantity		3

DIMENSIONS

Unit Dimensions (in)	Height	11 3/4
	Width	55 1/8
	Depth	27 1/2

Liquid Pipe Connection (in)	3/8
Gas Pipe Connection (in)	5/8
Drain Pipe Connection (in)	1
Shipping Weight (lb)	148
Net Weight (lb)	128

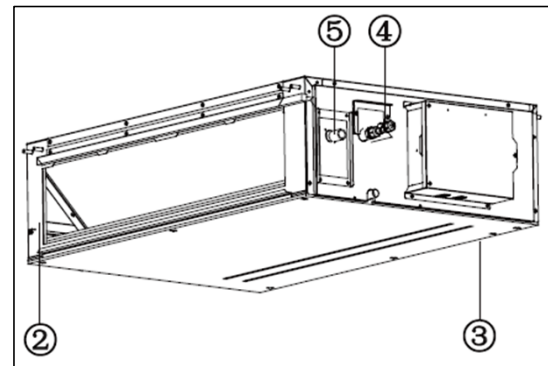

1. Air Filter
2. Air Inlet
3. Air Outlet
4. Fittings
5. Drain Pipe

NOTES:

*Cooling and Heating Capacity data is rated at the following conditions:

Cooling: 80 °F DB / 67 °F WB Indoor, 95 °F DB Outdoor

Heating: 70 °F DB Indoor, 47 °F DB



NOTE – Due to Lennox' ongoing commitment to quality, Specifications, Ratings and Dimensions subject to change without notice and without incurring liability. Improper installation, adjustment, alteration, service or maintenance can cause property damage or personal injury. Installation and service must be performed by a qualified installer and servicing agency. ©2019 Lennox Industries Inc.



SUBMITTAL DATA - INDOOR UNIT
VEXD048C432P
VRF HIGH STATIC FAN COIL EVAPORATOR
208-230/1/60

DIMENSIONAL DRAWINGS

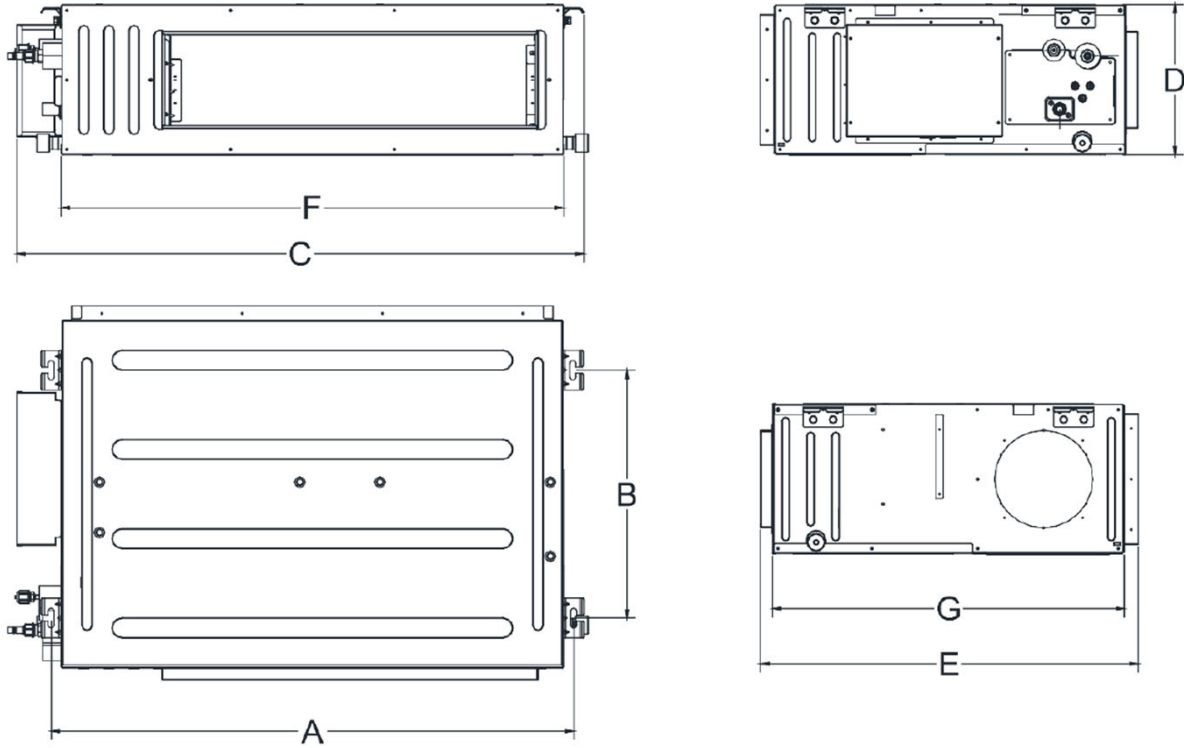

	mm	in
A	1440	56-11/16
B	500	19-11/16
C	1580	62-1/4
D	300	11-13/16
E	754	29-11/16
F	1400	55-1/8
G	700	27-9/16

NOTE – Due to Lennox' ongoing commitment to quality, Specifications, Ratings and Dimensions subject to change without notice and without incurring liability. Improper installation, adjustment, alteration, service or maintenance can cause property damage or personal injury. Installation and service must be performed by a qualified installer and servicing agency. ©2019 Lennox Industries Inc.