



**SUBMITTAL DATA - INDOOR UNIT**  
**VEAH009C432P**  
**VRF AIR HANDLER TYPE EVAPORATOR**  
**208-230/1/60**

Job Name: \_\_\_\_\_  
 Location: \_\_\_\_\_  
 Schedule No.: \_\_\_\_\_  
 System Designation: \_\_\_\_\_

Engineer: \_\_\_\_\_  
 Architect: \_\_\_\_\_  
 Date: \_\_\_\_\_  
 For: \_\_\_ Reference \_\_\_ Approval \_\_\_ Review \_\_\_ Construction

**FEATURES**

- Auto Addressing installation
- Auto Restart
- Horizontal or Vertical Installation
- Optional Ambient Temperature Sensor
- Built-in Electronic Expansion Valve
- Anti-Freezing Protection

**PRODUCT WARRANTY**

All covered components - one year limited warranty

**SPECIFICATIONS**

**PERFORMANCE**

Cooling Capacity* (Btu/h)		9,500
Heating Capacity* (Btu/h)		10,500
Airflow (CFM)	High	559
	Medium	500
	Low	383
Sound Pressure Level (dBA)	H / M / L	36/34/32

**ELECTRICAL DATA**

Power Supply (V / Ph / Hz)		208-230/1/60
MOCP (A)		15
Circuit Breaker (A)		15
MCA (A)		1.4
Rated Current (A)	Cooling	0.28
	Heating	0.28

**DIMENSIONS**

Unit Dimensions (in)	Height	43 1/2
	Width	18 1/8
	Depth	21 1/4
Liquid Pipe Connection (in)		1/4
Gas Pipe Connection (in)		3/8
Drain Pipe Connection (in)		1
Shipping Weight (lb)		128
Net Weight (lb)		119



**NOTES:**

\*Cooling and Heating Capacity data is rated at the following conditions:

Cooling: 80 °F DB / 67 °F WB Indoor, 95 °F DB Outdoor

Heating: 70 °F DB Indoor, 47 °F DB



NOTE – Due to Lennox' ongoing commitment to quality, Specifications, Ratings and Dimensions subject to change without notice and without incurring liability. Improper installation, adjustment, alteration, service or maintenance can cause property damage or personal injury. Installation and service must be performed by a qualified installer and servicing agency. ©2021 Lennox Industries Inc.



**SUBMITTAL DATA - INDOOR UNIT**  
**VEAH009C432P**  
**VRF AIR HANDLER TYPE EVAPORATOR**  
**208-230/1/60**

**DIMENSIONAL DRAWINGS**

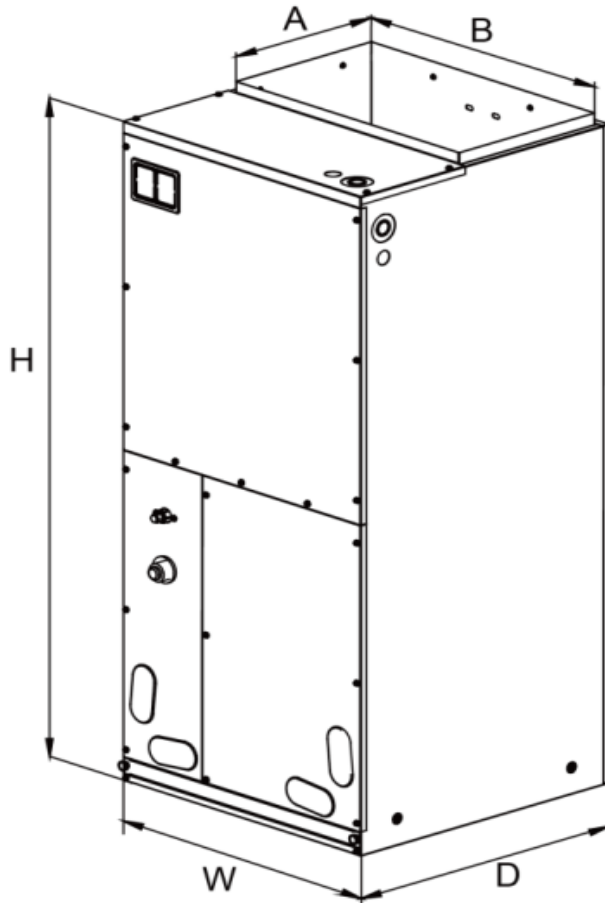

	mm	in
W	460	18.11
D	540	21.26
H	1105	43.50
A	295	11.61
B	426	16.77

NOTE – Due to Lennox' ongoing commitment to quality, Specifications, Ratings and Dimensions subject to change without notice and without incurring liability. Improper installation, adjustment, alteration, service or maintenance can cause property damage or personal injury. Installation and service must be performed by a qualified installer and servicing agency. ©2021 Lennox Industries Inc.