



SUBMITTAL DATA - INDOOR UNIT
VEAH024C432P
VRF AIR HANDLER TYPE EVAPORATOR
208-230/1/60

Job Name: _____
 Location: _____
 Schedule No.: _____
 System Designation: _____

Engineer: _____
 Architect: _____
 Date: _____
 For: ___ Reference ___ Approval ___ Review ___ Construction

FEATURES

- Auto Addressing installation
- Auto Restart
- Horizontal or Vertical Installation
- Optional Ambient Temperature Sensor
- Built-in Electronic Expansion Valve
- Anti-Freezing Protection

PRODUCT WARRANTY

All covered components - one year limited warranty

SPECIFICATIONS

PERFORMANCE

Cooling Capacity* (Btu/h)		24,000
Heating Capacity* (Btu/h)		27,000
Airflow (CFM)	High	824
	Medium	706
	Low	706
Sound Pressure Level (dBA)	H / M / L	45/43/41

ELECTRICAL DATA

Power Supply (V / Ph / Hz)		208-230/1/60
MOCP (A)		15
Circuit Breaker (A)		15
MCA (A)		1.4
Rated Current (A)	Cooling	1.1
	Heating	1.1

DIMENSIONS

Unit Dimensions (in)	Height	43 1/2
	Width	18 1/8
	Depth	21 1/4
Liquid Pipe Connection (in)		3/8
Gas Pipe Connection (in)		5/8
Drain Pipe Connection (in)		1
Shipping Weight (lb)		135
Net Weight (lb)		124



NOTES:

*Cooling and Heating Capacity data is rated at the following conditions:

Cooling: 80 °F DB / 67 °F WB Indoor, 95 °F DB Outdoor

Heating: 70 °F DB Indoor, 47 °F DB



NOTE – Due to Lennox' ongoing commitment to quality, Specifications, Ratings and Dimensions subject to change without notice and without incurring liability. Improper installation, adjustment, alteration, service or maintenance can cause property damage or personal injury. Installation and service must be performed by a qualified installer and servicing agency. ©2021 Lennox Industries Inc.



SUBMITTAL DATA - INDOOR UNIT
VEAH024C432P
VRF AIR HANDLER TYPE EVAPORATOR
208-230/1/60

DIMENSIONAL DRAWINGS

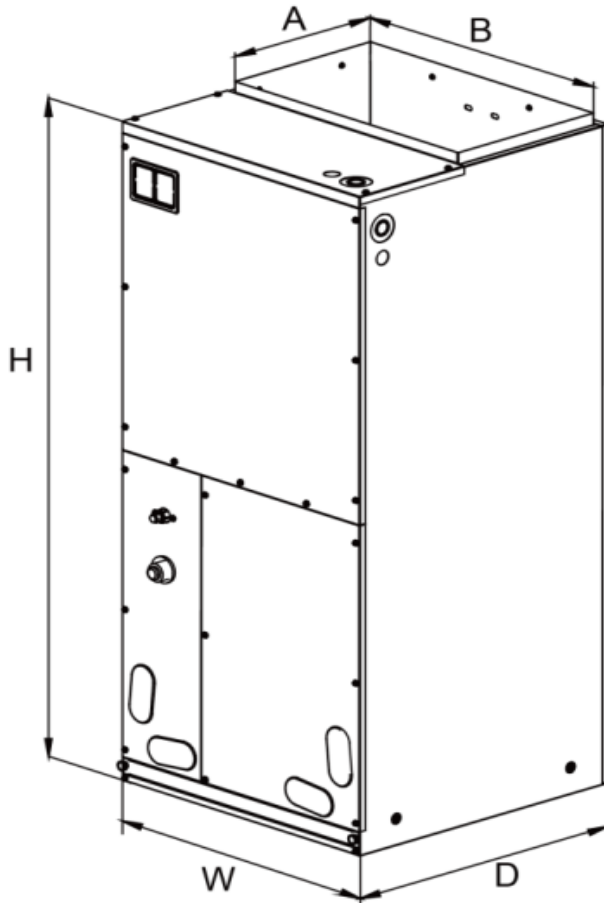

	mm	in
W	460	18.13
D	540	21.25
H	1105	43.50
A	295	11.63
B	426	16.75

NOTE – Due to Lennox' ongoing commitment to quality, Specifications, Ratings and Dimensions subject to change without notice and without incurring liability. Improper installation, adjustment, alteration, service or maintenance can cause property damage or personal injury. Installation and service must be performed by a qualified installer and servicing agency. ©2021 Lennox Industries Inc.