



SUBMITTAL DATA - INDOOR UNIT
VE8K034N432U
VRF STD 8-WAY CASSETTE TYPE EVAPORATOR
(360° Discharge)

Job Name: _____
Location: _____
Schedule No.: _____
System Designation: _____

Engineer: _____
Architect: _____
Date: _____
For: ___ Reference ___ Approval ___ Review ___ Construction

FEATURES

- Auto Addressing installation
- Auto Restart
- Replaceable Front Panel
- Integrated Condensate Pump
- Built-in Electronic Expansion Valve
- LED Display
- Washable Filter
- Water Overflow Protection
- Anti-Freezing Protection

PRODUCT WARRANTY

All covered components - Five year limited warranty

SPECIFICATIONS

PERFORMANCE

Cooling Capacity* (Btu/h)		34,120
Heating Capacity* (Btu/h)		38,210
Airflow (CFM)	High	736
	Medium	588
	Low	530

Sound Pressure Level (dBA) H / M / L 37/34/49

ELECTRICAL DATA

Power Supply (V / Hz / Ph)	220-240/50/1 - 208-230/60/1
MOP (A)	6
Rated Current (A)	Cooling 0.4
	Heating 0.4

DIMENSIONS

Unit Dimensions (in)	Height	9 1/2
	Width	33
	Depth	33

Liquid Pipe Connection (in)	3/8
Gas Pipe Connection (in)	5/8
Shipping Weight (lb)	81.6
Net Weight (lb)	63.9

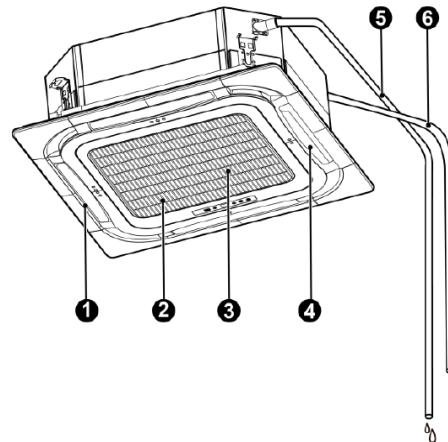

1. Air Outlet
2. Air Filter
3. Grill
4. Louvers
5. Pipe fittings
6. Drain Pipe

NOTES:

*Cooling and Heating Capacity data is rated at the following conditions:

Cooling: 80 °F DB / 67 °F WB Indoor, 95 °F DB Outdoor

Heating: 70 °F DB Indoor, 47 °F DB

NOTE – Due to Lennox' ongoing commitment to quality, Specifications, Ratings and Dimensions subject to change without notice and without incurring liability. Improper installation, adjustment, alteration, service or maintenance can cause property damage or personal injury. Installation and service must be performed by a qualified installer and servicing agency. ©2020 Lennox Industries Inc.



SUBMITTAL DATA - INDOOR UNIT
VE8K034N432U
VRF STD 8-WAY CASSETTE TYPE EVAPORATOR

DIMENSIONAL DRAWINGS

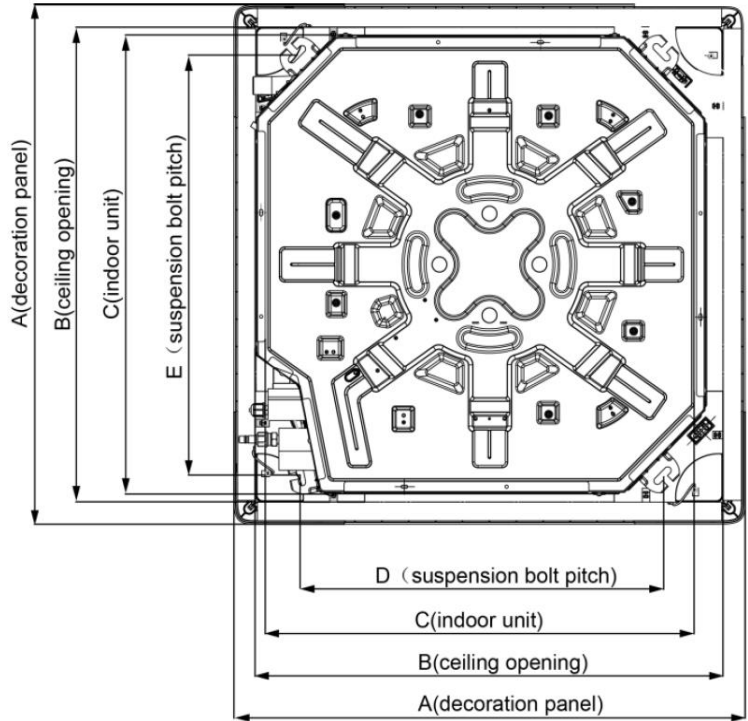

	mm	in
A	950	37.40
B	890	35.04
C	840	33.07
D	680	26.77
E	780	30.71

NOTE – Due to Lennox' ongoing commitment to quality, Specifications, Ratings and Dimensions subject to change without notice and without incurring liability. Improper installation, adjustment, alteration, service or maintenance can cause property damage or personal injury. Installation and service must be performed by a qualified installer and servicing agency. ©2020 Lennox Industries Inc.