



SUBMITTAL DATA - INDOOR UNIT
VE1C007C432P
1-WAY CASSETTE TYPE EVAPORATOR
208-230/1/60

Job Name: _____
 Location: _____
 Schedule No.: _____
 System Designation: _____

Engineer: _____
 Architect: _____
 Date: _____
 For: ___ Reference ___ Approval ___ Review ___ Construction

FEATURES

- Auto Addressing installation
- Auto Restart
- Replaceable Front Panel
- Integrated Condensate Pump
- Built-in Electronic Expansion Valve
- LED Display
- Washable Filter
- Water Overflow Protection
- Anti-Freezing Protection

SPECIFICATIONS

PERFORMANCE

Cooling Capacity* (Btu/h)		7,500
Heating Capacity* (Btu/h)		8,500
Airflow (CFM)	High	353
	Medium	294
	Low	265

Sound Pressure Level (dBA) H / M / L 36/32/28

ELECTRICAL DATA

Power Supply (V / Ph / Hz)		208-230/1/60
MOCP (A)		6
MCA (A)		2
Rated Current (A)	Cooling	0.2
	Heating	0.2

DIMENSIONS

Unit Dimensions (in)	Height	7
	Width	38 7/8
	Depth	15 1/5

Panel Dimensions (in)	Height	2 1/5
	Width	47 1/4
	Depth	18 1/8

Liquid Pipe Connection (in)	1/4
Gas Pipe Connection (in)	3/8

Shipping Weight (lb)	44
Net Weight (lb)	60
Panel Shipping Weight (lb)	9.3
Panel Net Weight (lb)	13.2

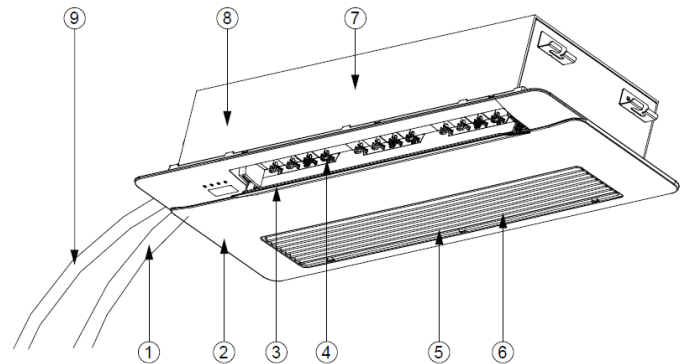

- 1. Refrigerant Pipes
- 2. Front Panel
- 3. Louvers
- 4. Swing Blades
- 5. Grill
- 6. Washable Filter
- 7. Body
- 8. Condensate Pump
- 9. Drain Pipe

NOTES:

*Cooling and Heating Capacity data is rated at the following conditions:

Cooling: 80 °F DB / 67 °F WB Indoor, 95 °F DB Outdoor

Heating: 70 °F DB Indoor, 47 °F DB



NOTE – Due to Lennox' ongoing commitment to quality, Specifications, Ratings and Dimensions subject to change without notice and without incurring liability. Improper installation, adjustment, alteration, service or maintenance can cause property damage or personal injury. Installation and service must be performed by a qualified installer and servicing agency. ©2020 Lennox Industries Inc.



SUBMITTAL DATA - INDOOR UNIT
VE1C007C432P
1-WAY CASSETTE TYPE EVAPORATOR
208-230/1/60

DIMENSIONAL DRAWINGS

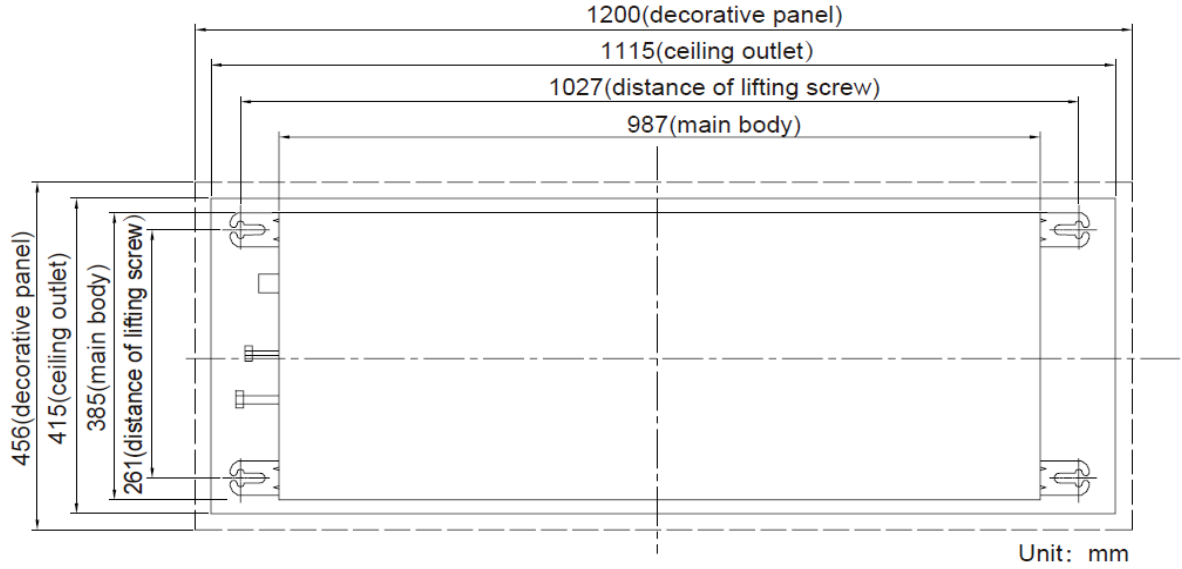

	mm	in
Decorative Panel	1200	47 1/4
Ceiling Outlet	1115	43 8/9
Hangers	1027	40 3/7
Main Body	987	38 6/7
Decorative Panel	145	5 5/7
Ceiling Outlet	240	9 4/9
Main Body	385	15 1/6
Hangers	261	10 2/7

NOTE – Due to Lennox' ongoing commitment to quality, Specifications, Ratings and Dimensions subject to change without notice and without incurring liability. Improper installation, adjustment, alteration, service or maintenance can cause property damage or personal injury. Installation and service must be performed by a qualified installer and servicing agency. ©2020 Lennox Industries Inc.