



SUBMITTAL DATA - INDOOR UNIT
VE4C027N432U
VRF STD 4-WAY CASSETTE TYPE EVAPORATOR

Job Name: _____
Location: _____
Schedule No.: _____
System Designation: _____

Engineer: _____
Architect: _____
Date: _____
For: ___ Reference ___ Approval ___ Review ___ Construction

FEATURES

- Auto Addressing installation
- Auto Restart
- Replaceable Front Panel
- Integrated Condensate Pump
- Built-in Electronic Expansion Valve
- LED Display
- Washable Filter
- Water Overflow Protection
- Anti-Freezing Protection

PRODUCT WARRANTY

All covered components - Five year limited warranty

SPECIFICATIONS

PERFORMANCE

Cooling Capacity* (Btu/h)		27,296
Heating Capacity* (Btu/h)		30,708
Airflow (CFM)	High	695
	Medium	559
	Low	550

Sound Pressure Level (dBA) H / M / L 38/36/33

ELECTRICAL DATA

Power Supply (V / Hz / Ph)	220-240/50/1 - 208-230/60/1
MOP (A)	6
Rated Current (A)	Cooling 0.3
	Heating 0.3

DIMENSIONS

Unit Dimensions (in)	Height	9 1/2
	Width	33
	Depth	33

Liquid Pipe Connection (in)	3/8
Gas Pipe Connection (in)	5/8
Shipping Weight (lb)	76
Net Weight (lb)	58.5

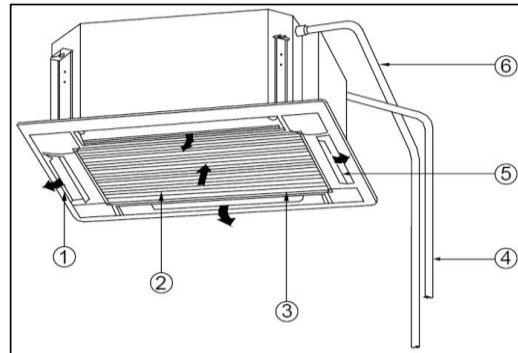

1. Air Outlet
2. Air Filter
3. Grill
4. Refrigerant Piping
5. Louvers
6. Drain Pipe

NOTES:

*Cooling and Heating Capacity data is rated at the following conditions:

Cooling: 80 °F DB / 67 °F WB Indoor, 95 °F DB Outdoor

Heating: 70 °F DB Indoor, 47 °F DB

NOTE – Due to Lennox' ongoing commitment to quality, Specifications, Ratings and Dimensions subject to change without notice and without incurring liability. Improper installation, adjustment, alteration, service or maintenance can cause property damage or personal injury. Installation and service must be performed by a qualified installer and servicing agency. ©2017 Lennox Industries Inc.



SUBMITTAL DATA - INDOOR UNIT
VE4C027N432U
VRF STD 4-WAY CASSETTE TYPE EVAPORATOR

DIMENSIONAL DRAWINGS

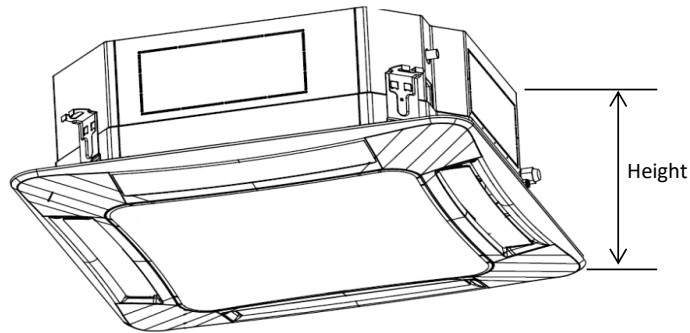
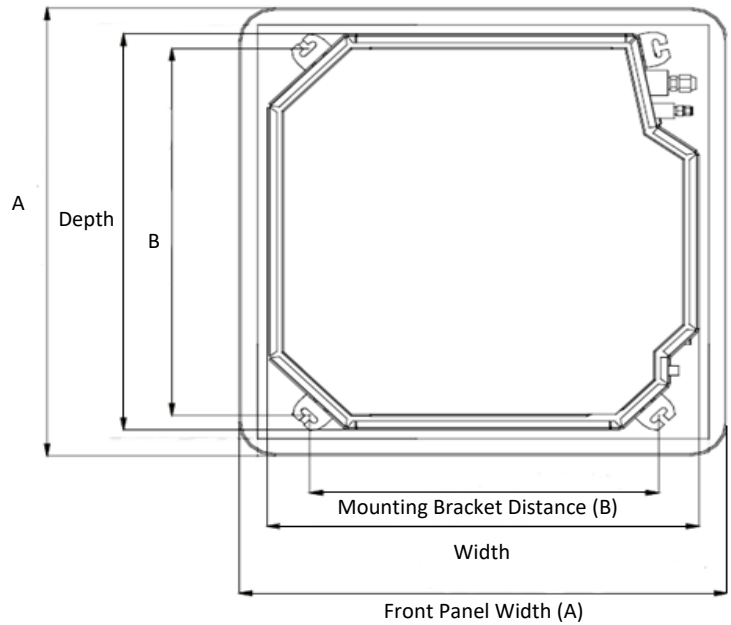

	mm	in
Width	840	33.07
Depth	840	33.07
Height	240	9.45
A	950	37.40
B	680	26.77

NOTE – Due to Lennox' ongoing commitment to quality, Specifications, Ratings and Dimensions subject to change without notice and without incurring liability. Improper installation, adjustment, alteration, service or maintenance can cause property damage or personal injury. Installation and service must be performed by a qualified installer and servicing agency. ©2017 Lennox Industries Inc.