



SUBMITTAL DATA - INDOOR UNIT
VE8C009C432P
VRF COMPACT 8-WAY CASSETTE
(360° Discharge)

Job Name: _____
 Location: _____
 Schedule No.: _____
 System Designation: _____

Engineer: _____
 Architect: _____
 Date: _____
 For: ___ Reference ___ Approval ___ Review ___ Construction

FEATURES

- Auto Addressing installation
- Auto Restart
- Replaceable Front Panel
- Integrated Condensate Pump
- Built-in Electronic Expansion Valve
- LED Display
- Washable Filter
- Water Overflow Protection
- Anti-Freezing Protection

PRODUCT WARRANTY

All covered components - Five year limited warranty

SPECIFICATIONS

PERFORMANCE

Cooling Capacity* (Btu/h)		9,500
Heating Capacity* (Btu/h)		10,500
Airflow (CFM)	High	335
	Medium	280
	Low	250

Sound Pressure Level (dBA) H / M / L 33/33/28

ELECTRICAL DATA

Power Supply (V / Hz / Ph)		208-230/60/1
MOCP (A)		15
MCA (A)		0.7
Rated Current (A)	Cooling	0.3
	Heating	0.3

DIMENSIONS

Unit Dimensions (in)	Height	10 4/9
	Width	22 4/9
	Depth	22 4/9

Liquid Pipe Connection (in)	1/4
Gas Pipe Connection (in)	3/8
Shipping Weight (lb)	49.6
Net Weight (lb)	38.6

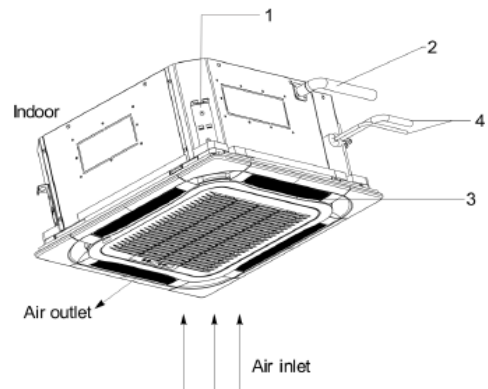

1. Condensate Pump
2. Drain Pipe
3. Louvers
4. Pipe fittings

NOTES:

*Cooling and Heating Capacity data is rated at the following conditions:

Cooling: 80 °F DB / 67 °F WB Indoor, 95 °F DB Outdoor
 Heating: 70 °F DB Indoor, 47 °F DB



NOTE – Due to Lennox' ongoing commitment to quality, Specifications, Ratings and Dimensions subject to change without notice and without incurring liability. Improper installation, adjustment, alteration, service or maintenance can cause property damage or personal injury. Installation and service must be performed by a qualified installer and servicing agency. ©2021 Lennox Industries Inc.

DIMENSIONAL DRAWINGS

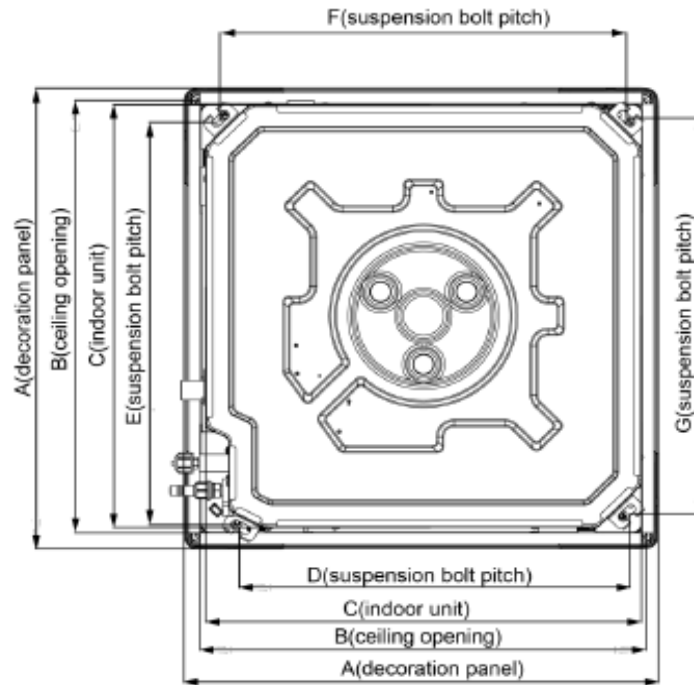

Fig.4.1.1

Unit: mm (inch)

Model	A	B	C	D	E	F	G
VE8C005C432P							
VE8C007C432P							
VE8C009C432P	620	580	570	505	550	530	530
VE8C012C432P	(24-3/8)	(22-13/16)	(22-7/16)	(19-7/8)	(22-5/8)	(20-7/8)	(20-7/8)
VE8C015C432P							
VE8C018C432P							

	mm	in
A	620	24.41
B	580	22.83
C	570	22.44
D	505	19.88
E	550	21.65
F	530	20.87
G	530	20.87

NOTE – Due to Lennox' ongoing commitment to quality, Specifications, Ratings and Dimensions subject to change without notice and without incurring liability. Improper installation, adjustment, alteration, service or maintenance can cause property damage or personal injury. Installation and service must be performed by a qualified installer and servicing agency. ©2021 Lennox Industries Inc.