



SUBMITTAL DATA - INDOOR UNIT VECC007N432U

VRF COMPACT 4-WAY CASSETTE TYPE EVAPORATOR

Job Name: _____
 Location: _____
 Schedule No.: _____
 System Designation: _____

Engineer: _____
 Architect: _____
 Date: _____
 For: ___ Reference ___ Approval ___ Review ___ Construction

FEATURES

- Auto Addressing installation
- Auto Restart
- Replaceable Front Panel
- Integrated Condensate Pump
- Built-in Electronic Expansion Valve
- LED Display
- Washable Filter
- Water Overflow Protection
- Anti-Freezing Protection

PRODUCT WARRANTY

All covered components - Five year limited warranty

SPECIFICATIONS

PERFORMANCE

Cooling Capacity* (Btu/h)		7,510
Heating Capacity* (Btu/h)		8,530
Airflow (CFM)	High	295
	Medium	265
	Low	235

Sound Pressure Level (dBA) H / M / L 46/--/--

ELECTRICAL DATA

Power Supply (V / Hz / Ph)	220-240/50/1 - 208-230/60/1
MOP (A)	6
Rated Current (A)	Cooling 0.4
	Heating 0.4

DIMENSIONS

Unit Dimensions (in)	Height	9 1/2
	Width	23 1/2
	Depth	23 1/2

Liquid Pipe Connection (in)	1/4
Gas Pipe Connection (in)	3/8
Shipping Weight (lb)	56.2
Net Weight (lb)	45.2

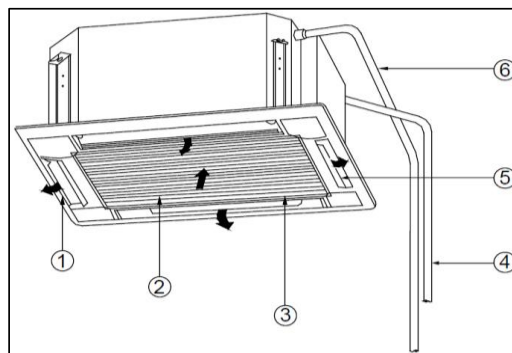

1. Air Outlet
2. Air Filter
3. Grill
4. Refrigerant Piping
5. Louvers
6. Drain Pipe

NOTES:

*Cooling and Heating Capacity data is rated at the following conditions:

Cooling: 80 °F DB / 67 °F WB Indoor, 95 °F DB Outdoor

Heating: 70 °F DB Indoor, 47 °F DB

NOTE – Due to Lennox' ongoing commitment to quality, Specifications, Ratings and Dimensions subject to change without notice and without incurring liability. Improper installation, adjustment, alteration, service or maintenance can cause property damage or personal injury. Installation and service must be performed by a qualified installer and servicing agency. ©2017 Lennox Industries Inc.



SUBMITTAL DATA - INDOOR UNIT
VECC007N432U
= COMPACT 4-WAY CASSETTE TYPE EVAPORATOR

DIMENSIONAL DRAWINGS

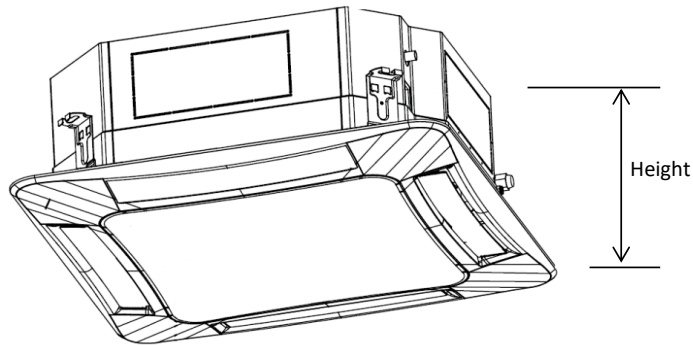
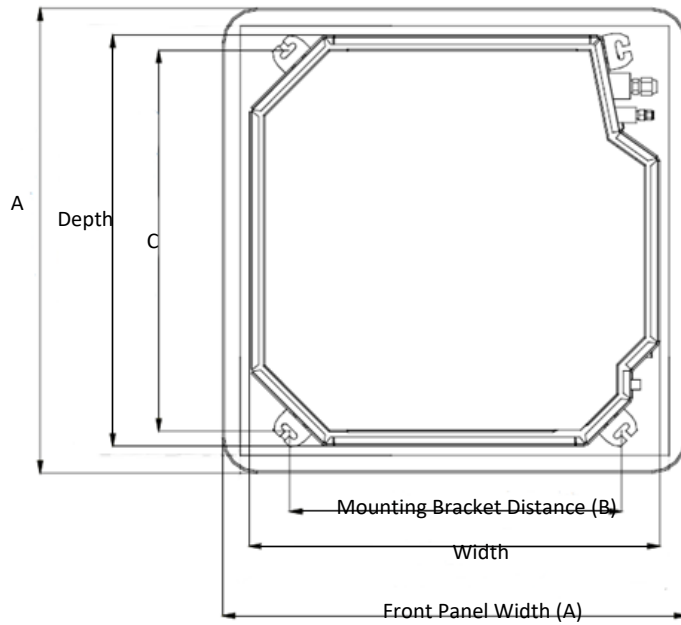

	mm	in
Width	596	23.46
Depth	596	23.46
Height	240	9.45
A	670	26.38
B	787	30.98
C	592	23.31

NOTE – Due to Lennox' ongoing commitment to quality, Specifications, Ratings and Dimensions subject to change without notice and without incurring liability. Improper installation, adjustment, alteration, service or maintenance can cause property damage or personal injury. Installation and service must be performed by a qualified installer and servicing agency. ©2017 Lennox Industries Inc.