



SUBMITTAL DATA - INDOOR UNIT

VECC015C432P

VRF COMPACT 4-WAY CASSETTE TYPE EVAPORATOR

208-230/1/60

Job Name: _____
 Location: _____
 Schedule No.: _____
 System Designation: _____

Engineer: _____
 Architect: _____
 Date: _____
 For: ___ Reference ___ Approval ___ Review ___ Construction

FEATURES

- Auto Addressing installation
- Auto Restart
- Replaceable Front Panel
- Integrated Condensate Pump
- Built-in Electronic Expansion Valve
- LED Display
- Washable Filter
- Water Overflow Protection
- Anti-Freezing Protection

PRODUCT WARRANTY

All covered components - one year limited warranty

SPECIFICATIONS

PERFORMANCE

Cooling Capacity* (Btu/h)		15,000
Heating Capacity* (Btu/h)		17,000
Airflow (CFM)	High	410
	Medium	355
	Low	283

Sound Pressure Level (dBA) H / M / L 45/43/38

ELECTRICAL DATA

Power Supply (V / Ph / Hz)		208-230/1/60
MOP (A)		15
Circuit Breaker (A)		15
MCA (A)		2
Rated Current (A)	Cooling	<1
	Heating	<1

DIMENSIONS

Unit Dimensions (in)	Height	9 1/2
	Width	23 1/2
	Depth	23 1/2
Panel Unit Dimensions (in)	Height	2
	Width	23 3/8
	Depth	23 3/8
Liquid Pipe Connection (in)		1/4
Gas Pipe Connection (in)		1/2
Shipping Weight (lb)		49
Net Weight (lb)		60
Panel Shipping Weight (lb)		8
Panel Net Weight (lb)		11

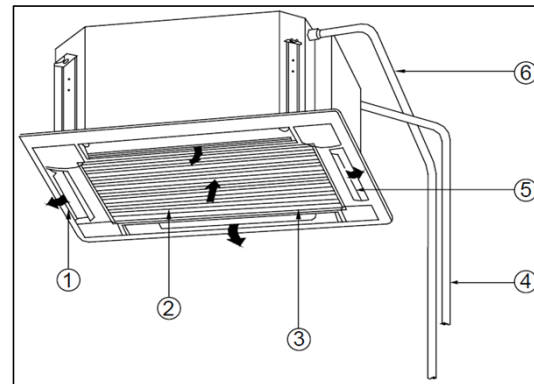

1. Air Outlet
2. Air Filter
3. Grill
4. Refrigerant Piping
5. Louvers
6. Drain Pipe

NOTES:

*Cooling and Heating Capacity data is rated at the following conditions:

Cooling: 80 °F DB / 67 °F WB Indoor, 95 °F DB Outdoor

Heating: 70 °F DB Indoor, 47 °F DB



NOTE – Due to Lennox' ongoing commitment to quality, Specifications, Ratings and Dimensions subject to change without notice and without incurring liability. Improper installation, adjustment, alteration, service or maintenance can cause property damage or personal injury. Installation and service must be performed by a qualified installer and servicing agency. ©2019 Lennox Industries Inc.



SUBMITTAL DATA - INDOOR UNIT

VECC015C432P

VRF COMPACT 4-WAY CASSETTE TYPE EVAPORATOR

208-230/1/60

DIMENSIONAL DRAWINGS

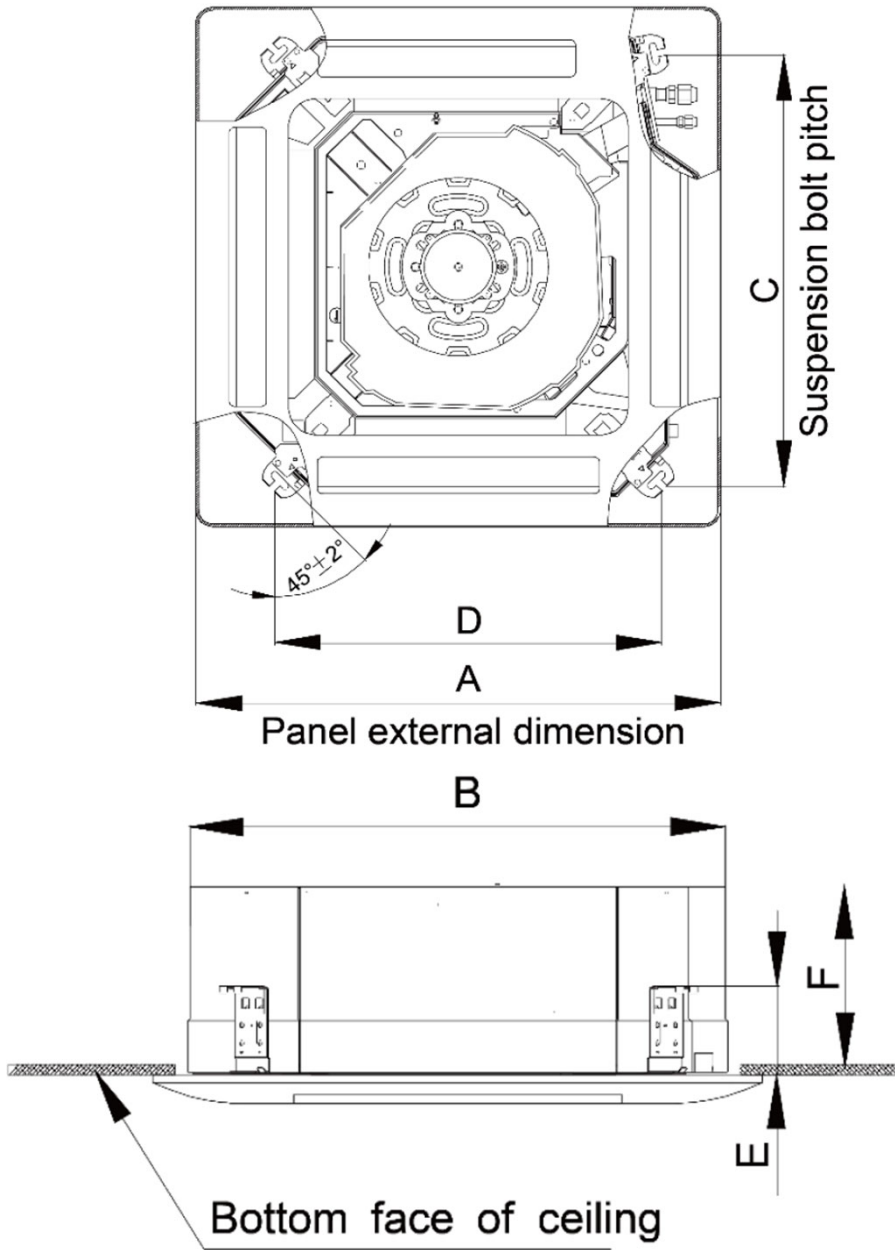

	mm	in
A	670	26 3/8
B	596	23 1/2
C	592	23 1/3
D	571	22 1/2
E	145	5 5/7
F	240	9 1/2

NOTE – Due to Lennox' ongoing commitment to quality, Specifications, Ratings and Dimensions subject to change without notice and without incurring liability. Improper installation, adjustment, alteration, service or maintenance can cause property damage or personal injury. Installation and service must be performed by a qualified installer and servicing agency. ©2019 Lennox Industries Inc.