



SUBMITTAL DATA - INDOOR UNIT

VEXD007N432U

VRF SUPER HIGH STATIC FAN COIL EVAPORATOR

Job Name: _____
 Location: _____
 Schedule No.: _____
 System Designation: _____

Engineer: _____
 Architect: _____
 Date: _____
 For: ___ Reference ___ Approval ___ Review ___ Construction

FEATURES

- Auto Addressing installation
- Auto Restart
- Adjustable ESP Setting
- Integrated Condensate Pump
- Built-in Electronic Expansion Valve
- LED Display Optional
- Flare Connections
- Anti-Freezing Protection
- Steel Cabinet

PRODUCT WARRANTY

All covered components - Five year limited warranty

SPECIFICATIONS

PERFORMANCE

Cooling Capacity* (Btu/h)		7,506
Heating Capacity* (Btu/h)		8,530
Airflow (CFM)	High	325
	Medium	290
	Low	235
External Static Pressure	Pa	0 - 150
	in. WC	0 - 0.603
Sound Pressure Level (dBA)	H / M / L	33/30/28



ELECTRICAL DATA

Power Supply (V / Ph / Hz)	220-240/1/50 - 208-230/1/60	
MOP (A)		6
Rated Current (A)	Cooling	0.5
	Heating	0.5

DIMENSIONS

Unit Dimensions (in)	Height	11-13/16
	Width	27-9/16
	Depth	27-9/16

Liquid Pipe Connection (in)	1/4
Gas Pipe Connection (in)	3/8
Shipping Weight (lb)	83.79
Net Weight (lb)	70.56

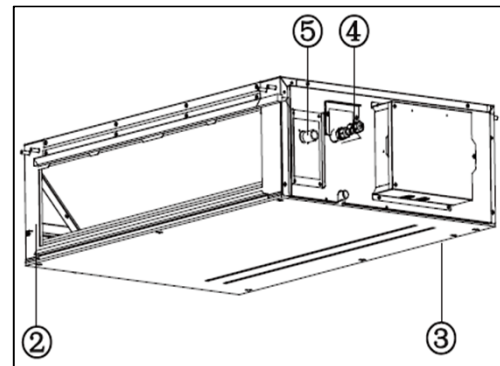

1. Air Filter
2. Air Inlet
3. Air Outlet
4. Fittings
5. Drain Pipe

NOTES:

*Cooling and Heating Capacity data is rated at the following conditions:

Cooling: 80 °F DB / 67 °F WB Indoor, 95 °F DB Outdoor

Heating: 70 °F DB Indoor, 47 °F DB

NOTE – Due to Lennox' ongoing commitment to quality, Specifications, Ratings and Dimensions subject to change without notice and without incurring liability. Improper installation, adjustment, alteration, service or maintenance can cause property damage or personal injury. Installation and service must be performed by a qualified installer and servicing agency. ©2017 Lennox Industries Inc.



SUBMITTAL DATA - INDOOR UNIT
VEXD007N432U
VRF SUPER HIGH STATIC FAN COIL EVAPORATOR

DIMENSIONAL DRAWINGS

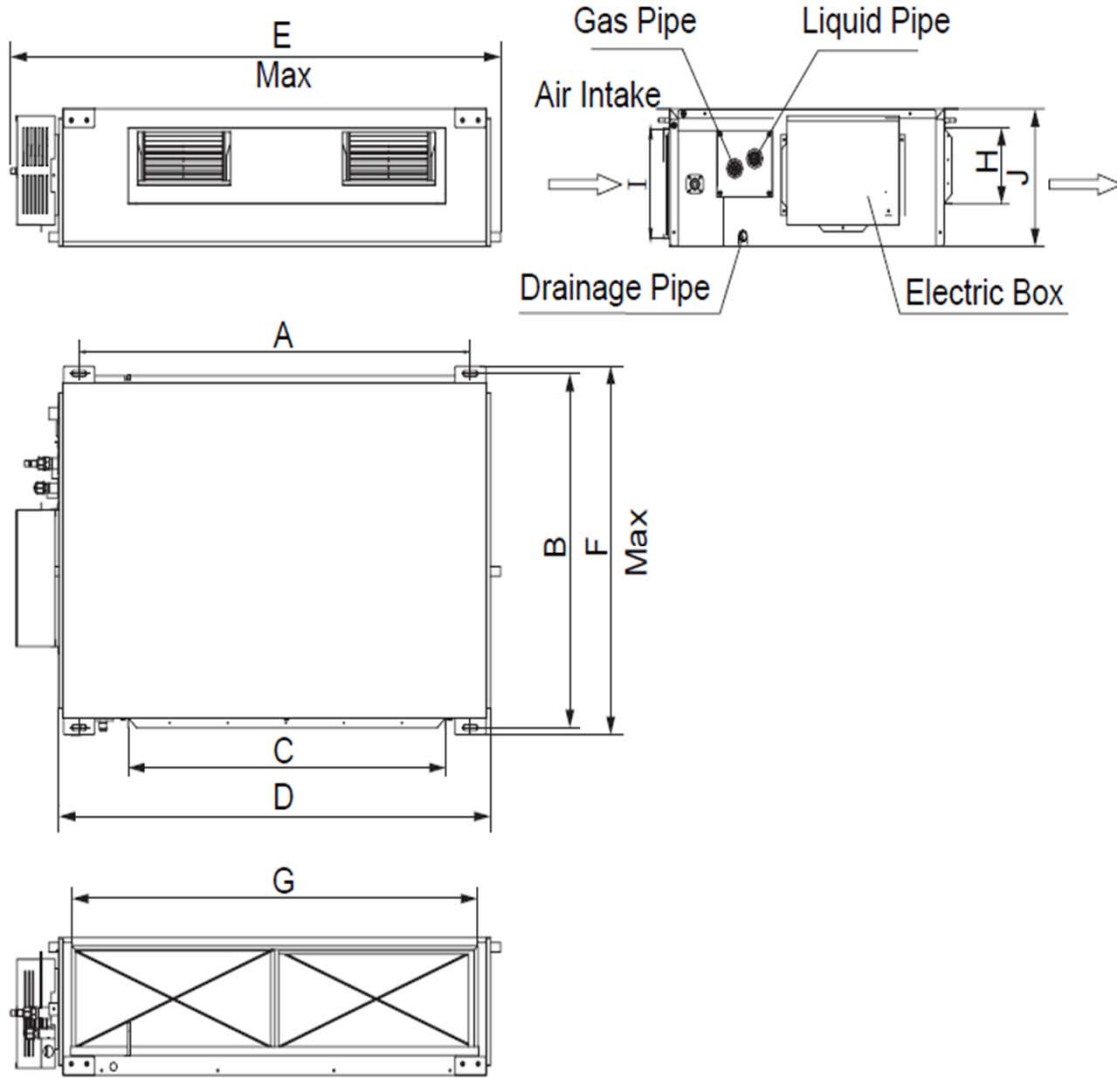

	mm	in
B	700	27-9/16
D	700	27-9/16
J	300	11-13/16

NOTE – Due to Lennox' ongoing commitment to quality, Specifications, Ratings and Dimensions subject to change without notice and without incurring liability. Improper installation, adjustment, alteration, service or maintenance can cause property damage or personal injury. Installation and service must be performed by a qualified installer and servicing agency. ©2017 Lennox Industries Inc.