



# SUBMITTAL DATA - INDOOR UNIT

**VEXD013N432U**

## VRF SUPER HIGH STATIC FAN COIL EVAPORATOR

Job Name: \_\_\_\_\_  
 Location: \_\_\_\_\_  
 Schedule No.: \_\_\_\_\_  
 System Designation: \_\_\_\_\_

Engineer: \_\_\_\_\_  
 Architect: \_\_\_\_\_  
 Date: \_\_\_\_\_  
 For: \_\_\_ Reference \_\_\_ Approval \_\_\_ Review \_\_\_ Construction

### FEATURES

- Auto Addressing installation
- Auto Restart
- Adjustable ESP Setting
- Integrated Condensate Pump
- Built-in Electronic Expansion Valve
- LED Display Optional
- Flare Connections
- Anti-Freezing Protection
- Steel Cabinet

### PRODUCT WARRANTY

All covered components - Five year limited warranty

### SPECIFICATIONS

#### PERFORMANCE

Cooling Capacity* (Btu/h)		13,648
Heating Capacity* (Btu/h)		15,354
Airflow (CFM)	High	500
	Medium	415
	Low	350
External Static Pressure	Pa	0 - 150
	in. WC	0 - 0.603
Sound Pressure Level (dBA)	H / M / L	36/34/32



#### ELECTRICAL DATA

Power Supply (V / Ph / Hz)	220-240/1/50 - 208-230/1/60
MOP (A)	6
Rated Current (A)	Cooling 0.5
	Heating 0.5

#### DIMENSIONS

Unit Dimensions (in)	Height	11-13/16
	Width	27-9/16
	Depth	27-9/16
Liquid Pipe Connection (in)		1/4
Gas Pipe Connection (in)		1/2
Shipping Weight (lb)		88.2
Net Weight (lb)		74.97

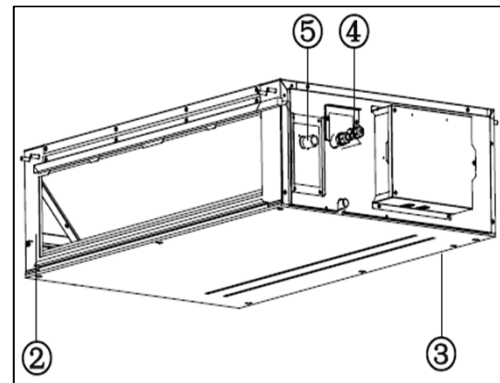

1. Air Filter
2. Air Inlet
3. Air Outlet
4. Fittings
5. Drain Pipe

#### NOTES:

\*Cooling and Heating Capacity data is rated at the following conditions:

Cooling: 80 °F DB / 67 °F WB Indoor, 95 °F DB Outdoor

Heating: 70 °F DB Indoor, 47 °F DB

NOTE – Due to Lennox' ongoing commitment to quality, Specifications, Ratings and Dimensions subject to change without notice and without incurring liability. Improper installation, adjustment, alteration, service or maintenance can cause property damage or personal injury. Installation and service must be performed by a qualified installer and servicing agency. ©2017 Lennox Industries Inc.



**SUBMITTAL DATA - INDOOR UNIT**  
**VEXD013N432U**  
**VRF SUPER HIGH STATIC FAN COIL EVAPORATOR**

**DIMENSIONAL DRAWINGS**

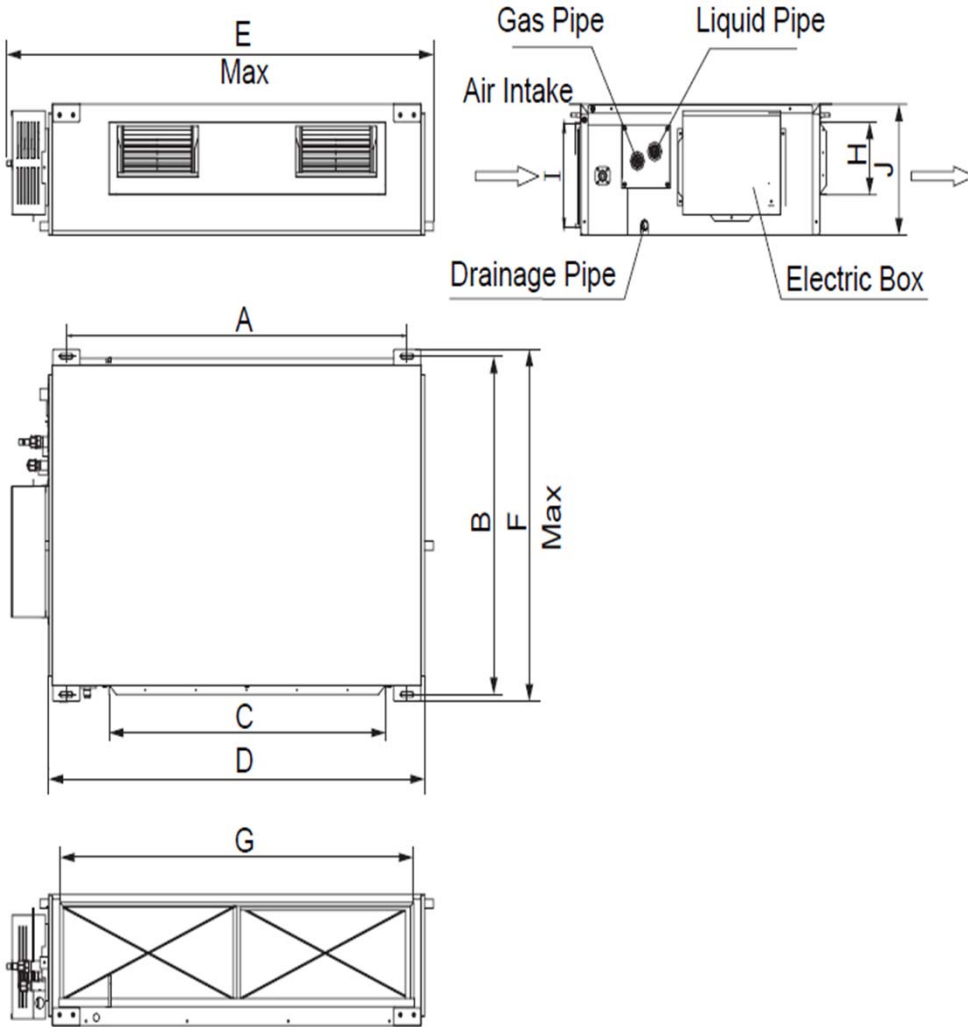

	mm	in
<b>B</b>	700	27-9/16
<b>D</b>	700	27-9/16
<b>J</b>	300	11-13/16

NOTE – Due to Lennox' ongoing commitment to quality, Specifications, Ratings and Dimensions subject to change without notice and without incurring liability. Improper installation, adjustment, alteration, service or maintenance can cause property damage or personal injury. Installation and service must be performed by a qualified installer and servicing agency. ©2017 Lennox Industries Inc.